

0 600 842 603

Stand 99-12

Issue 01-06-19

Fig./Abb. 2

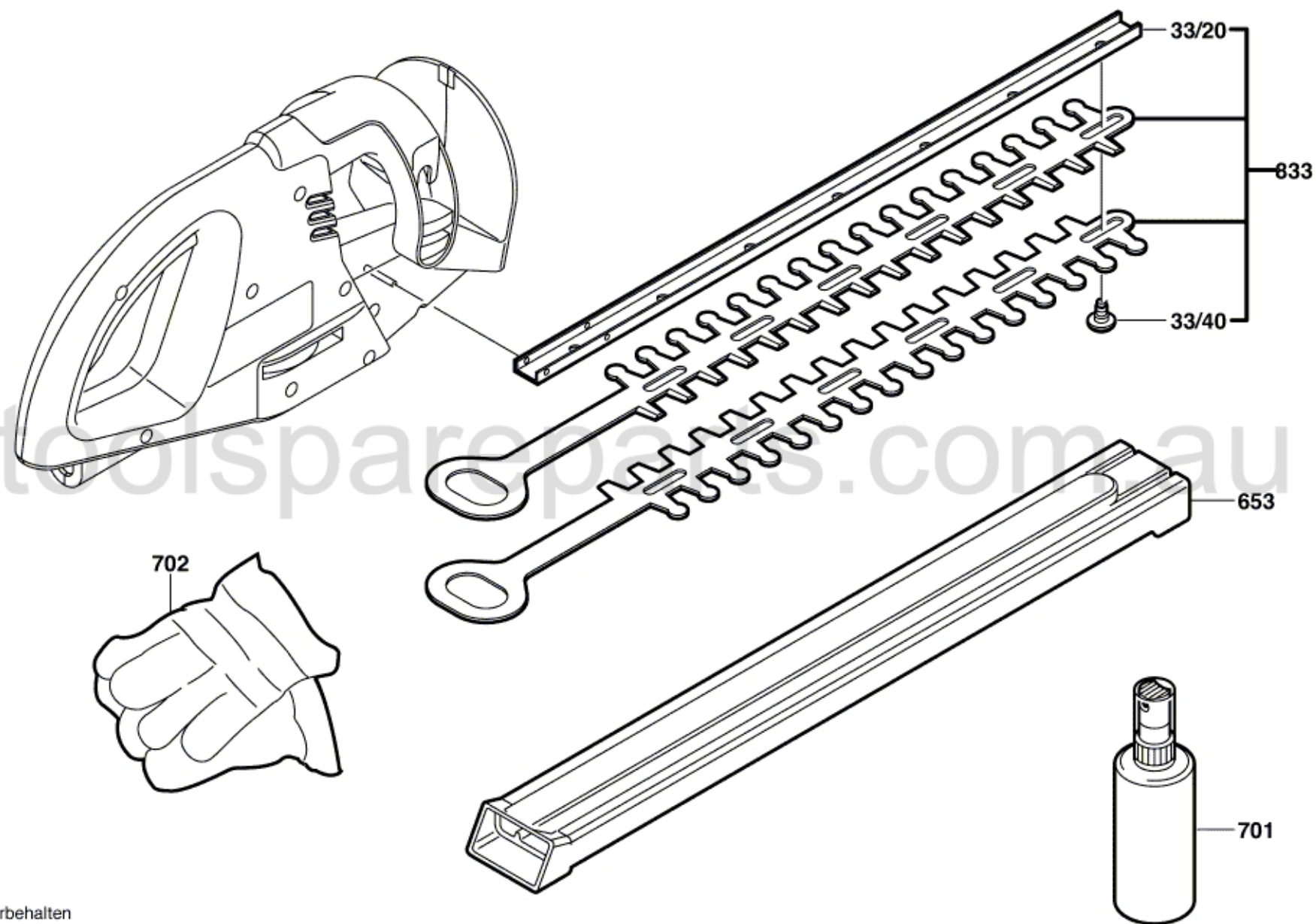

Änderungen vorbehalten
Modifications reserved
Modifications reserves
Salvo modificaciones